



250A/300A Professional MIG Welder 415V 3ph with BINZEL® Euro Torch

MODEL Nos: **POWERMIG3525, POWERMIG3530**

Thank you for purchasing a Sealey Welder. Manufactured to a high standard this product will, if used according to these instructions and properly maintained, give you years of trouble free performance.

IMPORTANT: BEFORE USING THIS PRODUCT, PLEASE READ THE INSTRUCTIONS CAREFULLY. MAKE CAREFUL NOTE OF SAFETY INSTRUCTIONS, WARNINGS AND CAUTIONS. THIS PRODUCT SHOULD ONLY BE USED FOR ITS INTENDED PURPOSE. FAILURE TO DO SO MAY CAUSE DAMAGE OR PERSONAL INJURY, AND WILL INVALIDATE THE WARRANTY. RETAIN THESE INSTRUCTIONS FOR FUTURE USE.



Refer to instructions



Wear a welding mask



Wear protective gloves



Wear safety footwear



Wear protective clothing



Electrical shock hazard



Hot surfaces



Do not use in the vicinity of a pacemaker



Welding sparks can cause explosions or fire.



Arc rays can burn eyes and injure skin.



Breathing welding fumes can be hazardous to your health.

1. SAFETY

1.1 ELECTRICAL SAFETY. WARNING! It is the user's responsibility to read, understand and comply with the following:

You must check all electrical equipment and appliances to ensure they are safe before using. You must inspect power supply leads, plugs and all electrical connections for wear and damage. You must ensure the risk of electric shock is minimised by the installation of appropriate safety devices. An RCCB (Residual Current Circuit Breaker) should be incorporated in the main distribution board. We also recommend that an RCD (Residual Current Device) is used with all electrical products. It is particularly important to use an RCD together with portable products that are plugged into an electrical supply not protected by an RCCB. If in doubt consult a professional electrician. You may obtain a Residual Current Device by contacting your Sealey dealer. **You must** also read and understand the following instructions concerning electrical safety.

- 1.1.1 The Electricity At Work Act 1989 requires all portable electrical appliances, if used on business premises, to be tested by a qualified Electrician at least once a year, using a Portable Appliance Tester (PAT).
- 1.1.2 The **Health & Safety at Work Act 1974** makes owners of electrical appliances responsible for the safe condition of the appliance, and the safety of the appliance operator. **If in any doubt about electrical safety, contact a qualified electrician.**
- 1.1.3 Ensure the insulation on all cables and the product itself is safe before connecting to the mains power supply. See 1.1.1. & 1.1.2. above and use a Portable Appliance Tester (PAT).
- 1.1.4 Ensure that cables are always protected against short circuit and overload.
- 1.1.5 Regularly inspect power supply, leads, plugs and all electrical connections for wear and damage, especially power connections, to ensure that none are loose.
- 1.1.6 **Important:** Ensure the voltage marked on the product is the same as the electrical power supply to be used, and check that plugs are fitted with correct capacity fuse.
- 1.1.7 **DO NOT** pull or carry the powered appliance by its power supply lead or output cables.
- 1.1.8 **DO NOT** pull power plugs from sockets by the power cable.
- 1.1.9 **DO NOT** use worn or damaged leads, plugs or connections. Immediately replace or have repaired by a qualified Electrician. These particular welders are supplied without a mains plug. Follow the instructions below regarding the fitting of an appropriate plug.

1.2 MODELS POWERMIG3525 & 3530 ARE 3 PHASE MACHINES AND MUST HAVE AN APPROPRIATE PLUG FITTED.

WARNING! ELECTRICAL INSTALLATION OF WELDER TO A 3 PHASE 415VOLT SUPPLY MUST ONLY BE CARRIED OUT BY A QUALIFIED ELECTRICIAN. Make sure the power supply cable is correctly connected to the Earth.

- 1.2.1 **This product must be fitted with a 3 phase plug according to figure 1, and will require a minimum of 16AMPS per phase, (preferably 32AMP) electrical supply. You must contact a qualified Electrician to ensure an appropriately fused supply is available.**
Connect GREEN/YELLOW wire to Earth 'E'
Connect BROWN wire to L1 Terminal.
Connect BLACK wire to L2 Terminal.
Connect the GREY wire to L3 Terminal.

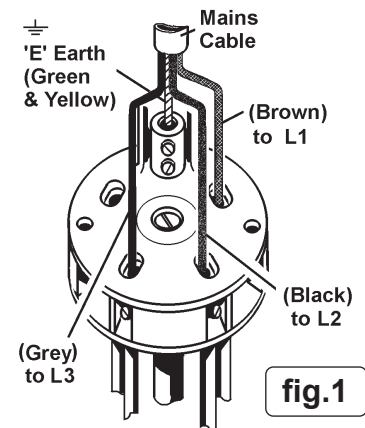

fig.1

When completed, check there are no bare wires, that all wires have been connected correctly and the cable restraint is tight. (NOTE: The cable core colours found in the mains cable on this welder are consistent with Amendment 2 to BS7671:2001 which harmonised UK cable core colours with those used in Europe.)

- 1.2.2 **DO NOT** use this product with a standard extension cable. Only use ARMoured extension cable.

1.3 GENERAL SAFETY

The operator should be properly trained to use the welder safely and should be informed about the risks relating to MIG and ARC welding procedures, the associated protection measures and emergency procedures. (Refer also to the "IEC TECHNICAL SPECIFICATION or CLC/TS 62081: INSTALLATION AND USE OF EQUIPMENT FOR ARC WELDING")

- ▲ **DANGER! Unplug the welder from the mains power supply before performing maintenance or service.**
- ✓ Keep the welder and cables in good working order and condition. (Take immediate action to repair or replace damaged parts).
- ✓ Use genuine parts and accessories only. (Non recommended parts may be dangerous and will invalidate the warranty).
- ✓ Use an air hose to regularly blow out any dirt from the liner and keep the welder clean for best and safest performance.
- ✓ Check and spray the gas cup and contact tip regularly with anti-spatter spray available from your Sealey dealer.
- ✓ Locate welder in adequate working area for its function. Ensure area has adequate ventilation as welding fumes are harmful.
- ✓ Keep working area clean, tidy and free from unrelated materials. Also ensure the working area has adequate lighting, and that a fire extinguisher is at hand.

- ☐ **WARNING: Always use a welding helmet or mask to protect your eyes.**
Use special fire resistant protective clothing and do not allow the skin to be exposed to the ultraviolet and infrared rays produced by the arc. Other people in the vicinity of the arc should be protected by shields of non reflecting welding curtains.
The operator should be adequately insulated from the electrode, the work piece and any accessible earthed metal parts in the vicinity by the wearing of safety shoes and welding gauntlets plus the aforementioned safety clothing.
Where necessary the operator should work on insulating mats or on an insulated safety platform in elevated positions.
 - ✓ Remove ill fitting clothing, remove ties, watches, rings, and other loose jewellery, and contain long hair.
 - ✓ Ensure the workpiece is correctly secured before operating the welder.
 - ✓ Avoid unintentional contact with workpiece. Accidental or uncontrolled use of the torch may be dangerous and will wear the nozzle.
 - ✓ Keep non essential persons away from the working area. Any persons working within the area must use protective head shield and gloves.
 - ✓ Operators must receive adequate training before using the welder. The welder must only be operated under supervision.
 - ✓ Stand correctly keeping a good footing and balance, and ensure the floor is not slippery, and wear non-slip shoes.
 - ✓ Turn voltage switch to "0" or off when not in use.
 - x **DO NOT** operate the welder if it or its cables are damaged and **DO NOT** attempt to fit any non genuine torches, components, or parts to the welder unit.
 - x **DO NOT** get welder wet or use in damp or wet locations or areas where there is condensation.
 - ▲ **DANGER! DO NOT weld near inflammable materials, solids, liquids, or gases, and DO NOT weld containers or pipes which have held flammable materials or gases, liquids or solids. Avoid operating on materials cleaned with chlorinated solvents or near such solvents.**
 - x **DO NOT** touch any live metal parts of the torch or electrode while the machine is switched on.
 - x **DO NOT** weld on any containers which are under pressure.
 - x **DO NOT** pull the welder by the mains cable or by the umbilical connection cable. **DO NOT** pull the wire feed unit by the umbilical connection cable or by the torch cable, and **DO NOT** bend or strain cables, protect from sharp or abrasive items, and **DO NOT** stand on cables or leads. Protect from heat. Long lengths of slack must be gathered & neatly coiled. **DO NOT** place cables where they endanger others.
 - x **DO NOT** touch the torch or workpiece immediately after welding as they will be very hot. Allow to cool.
 - x **DO NOT** operate welder while under the influence of drugs, alcohol or intoxicating medication, or if fatigued.
 - ✓ When not in use store the welder in a safe, dry, childproof area.
 - x **DO NOT** operate welder in damp or wet places and do not weld in the rain.
 - ✓ Provide adequate ventilation or facilities for the removal of for welding fumes from near the arc. The risk should be assessed by a Health and Safety professional in relation to the exposure limits for the welding fumes, which will depend on their composition, concentration and the exposure time
- 1.4 VOLTAGE BETWEEN ELECTORDE HOLDERS OR TORCHES.**
- x Working with more than one welding machine on a single piece or on pieces that are connected electrically may generate a dangerous amount of no-load voltage between the two electrode holders or torches, the value of which may reach double the allowed limit. Measuring instruments should be used to determine the existence of a risk and suitable precautions taken as detailed in section 5.9 of the IEC TECHNICAL SPECIFICATIONS OF CLC/TS 62081.
- 1.5 ELECTROMAGNETIC INTERFERENCE.**
- ✓ The electromagnetic fields generated by the welding process may interfere with the operation of electrical and electronic equipment. Users of vital electronic and electrical devices such as pacemakers and respirators are advised not to remain in the vicinity of an operating welding machine. If in doubt seek medical advice before entering a welding area. Users of such devices should not operate the welding machine. This welder complies with the requirements of the technical standard for the use of this type of product, only and exclusively in industrial environments and for professional purposes. It is not guaranteed to meet electronic compatibility requirements in the home.
- 1.6 GAS SAFETY**
- ✓ Store gas cylinders in a vertical position only and ensure the storage area is correctly secured.
- x **DO NOT** store gas cylinders in areas where temperature exceeds 50°C. **DO NOT** use direct heat on a cylinder. Always keep gas cylinders cool.
- x **DO NOT** attempt to repair or modify any part of a gas cylinder or valve, and **DO NOT** puncture or damage a cylinder.
- x **DO NOT** obscure or remove any official labels from a cylinder. Always check the gas identity before use. Avoid getting gas cylinders oily or greasy.
- x **DO NOT** try to lift or handle cylinder by its cap, guard or valve. Always keep caps and guards in place and close valve when not in use.
The gas cylinder is heavy, use mechanical lifting equipment. Ensure the cylinder is correctly situated on the welder base stand and secured with chain.
- 1.7 RISK ASSESSMENT**
- ✓ Where welding is unavoidable in awkward situations such as in confined spaces, in environments with increased risk of electric shock, and in the presence of inflammable or explosive materials, a risk assessment must be carried out by an experienced and qualified expert professional in consultation with providers of emergency services to ensure that operations are carried out in the safest possible way.

2. INTRODUCTION & SPECIFICATIONS

Tried and trusted by fabricators and professional car repair shops across the UK. Superb quality, heavy-duty electronic wire drive motor and industrial transformer make this machine unmatched in performance and value, just check the specification. Supplied with 0.8mm steel wire, non-live torch and industrial Argon/CO2 regulator. Can be used with CO2, Argon or CO2/Argon mix and accepts any bottle size.

Model:	POWERMIG3525	POWERMIG3530
Welding Current	40-250A	56-300A
Wire Capacity:	15kg	15kg
Duty Cycle:	100% @ 148A, 60% @ 190A, 35% @ 250A	100% @ 177A, 60% @ 229A, 35% @ 300A
Cooling System:	Turbo Fan	Turbo Fan
Spot Welding Timer:	Yes	Yes
Gas Type:	CO ₂ , Argon, CO ₂ /Argon Mix	CO ₂ , Argon, CO ₂ /Argon Mix
Torch:	3m Euro Non-Live - Binzel®MB24	3m Euro Non-Live - Binzel®MB24
Power Input:	415V - 3ph	415V - 3ph
Absorbed Power:	9.2kW	11.5kW
Case Size:	Extra Large	Extra Large

3. RATINGS PLATE SYMBOLS

Detailed technical data relative to the performance of the machine is located on the back panel. **Please note** that the ratings plate shown below (fig.2) is an example only intended to assist with the explanations of the symbols. To determine the correct technical values of the machine in your possession, you must refer to the data plate on that machine and the specifications shown above.

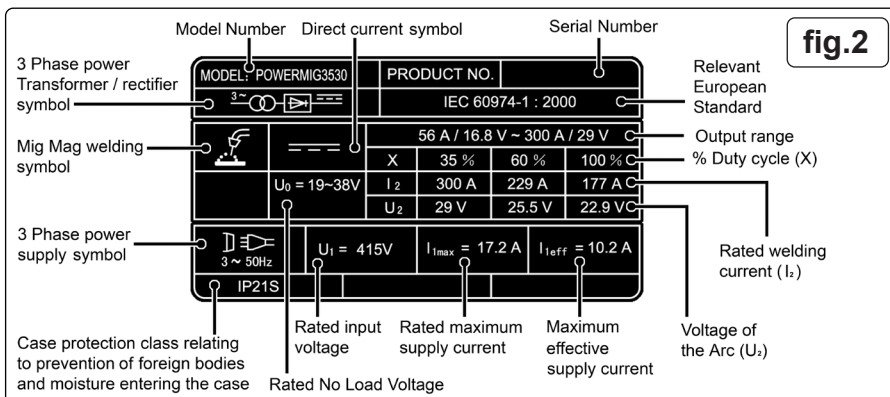

4. UNPACKING & CONTENTS

4.1 UNPACKING

Due to the weight of these welders it is a four man job to unpack them and some form of mechanical lifting device may be required. Open the carton and remove all the accessories and other loose items of packing. We recommend cutting away one end of the carton so that the welder can be wheeled out of the pack directly onto a hard concrete surface.

4.2 CONTENTS

4.2.1 MAIN WELDING UNIT.

Wire Feed Roller 0.8mm/1.0mm x 1

4.2.2 TORCH & CABLE with Euro connector.

Welding Tips 0.8 x 2

Welding Tips 1.0 x 2

Torch maintenance spanner

4.2.3 EARTH CLAMP CABLE

4.2.4 GAS REGULATOR

4.2.5 GAS BOTTLE RETAINING CHAIN

5. ASSEMBLY & INSTALLATION

5.1. WELDER ASSEMBLY

5.1.1 The welder comes with wheels and handles fully assembled.

5.2 CONNECT WELDER TO THE MAINS POWER SUPPLY.

5.2.1 Before making any electrical connections, ensure that the mains voltage and frequency of the supply matches the electrical specification of the welder as stated on the welder's rating plate.

5.2.2 The welder must only be connected to a three phase power supply with the neutral conductor connected to earth.

5.2.3 Refer to the section on electrical safety at the start of these instructions for information on the correct connection of the mains power plug.

5.3. CONNECT TORCH "Euro Connection".

Your welder is fitted with a "Euro Connection" quick release torch. Line up the pins in the torch connector with the appropriate holes in the socket on the front panel connector (fig.3), push in, engage and tighten the locking nut (fig.4).

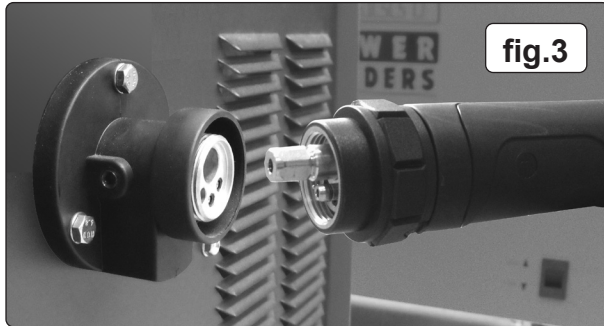

fig.3



fig.4

5.4 CONNECTING THE WELDING CURRENT RETURN CABLE (fig.6).

5.4.1 The earthing clamp (fig.5) should be firmly attached to the piece being welded (or to a metal bench supporting it), as close as possible to the joint being made.

5.4.2 The quick connector at the other end of the cable will be connected to the socket identified with a minus symbol (-) on the lower part of the front panel.

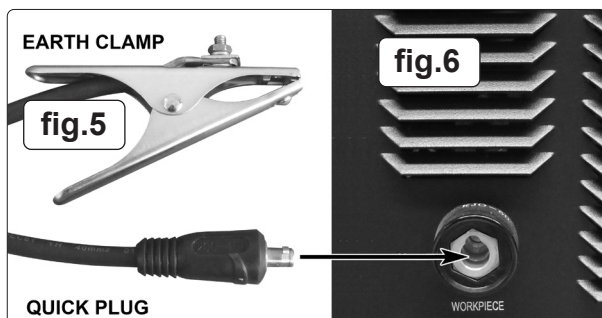

fig.6

5.5 CONNECTING THE GAS CYLINDER (fig.7 & 8).

5.5.1 Stand the gas cylinder on the platform at the rear of the welder and secure with chain supplied. The platform is designed to support bottles up to a maximum weight of 20kg.

5.5.2 If using Argon or Argon mixtures, you will need to use the "bull nosed adaptor" supplied. (If you intend to use CO₂ gas the regulator will fit directly onto the cylinder). If using the bull nosed adaptor, fit it to the cylinder first and tighten with a spanner.

5.5.3 Remove regulator from box and screw it to the bull nosed adaptor (or CO₂ cylinder). Slide a small jubilee clip over one end of the gas pipe supplied and push it onto the regulator gas outlet and secure it with the pipe clip supplied (fig 8). Tighten the jubilee clip. **Note: The regulator supplied may differ from that illustrated.**

5.5.4 Slide a jubilee clip over the other end of the gas pipe and push it onto the gas inlet fitting on the rear of the welder and secure it with the pipe clip supplied (fig 8). Tighten the jubilee clip.

5.5.5 Close the regulator by turning the adjusting knob anti-clockwise to relieve the pressure on the diaphragm before opening the cylinder valve. If this is not done, pressure from the cylinder can damage the diaphragm and render the regulator inoperative.

5.5.6 Set the regulator flow rate to 4litres/min depending on the material to be welded, also taking into consideration any draughts which are strong enough to disturb the gas flow.

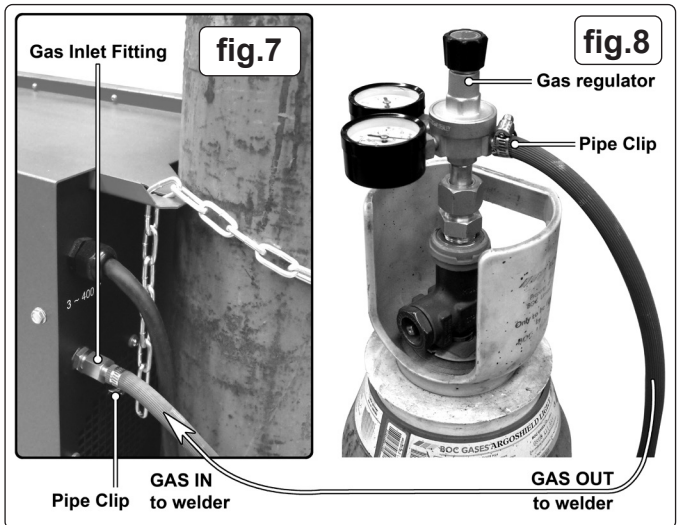

5.6 FIT A REEL OF WIRE. Ensure the welder is unplugged from the mains power. The wire feed reel holder will accept reels of wire up to 15kg as shown in fig.15.

5.6.1 Referring to fig.9, open the side of the wire feed compartment, and unscrew the reel retaining knob from the end of the rotating reel holder. Push the reel of wire onto the holder ensuring that the spool is rotating clockwise with the wire drawing off the top of the reel towards the flexible wire guide on the wire drive unit. The larger spools of wire have a 'moulded in' guide tube which must be located over the reel engagement pin on the rotating reel holder flange (See fig.9 below). The pin, in conjunction with the reel tension clutch adjuster will stop heavy reels of wire from free wheeling on the reel holder. See also 'setting wire tension' in section 6.4.

5.6.2 Retain the reel of wire on the holder by screwing the reel retaining knob back into place as indicated in fig.15.

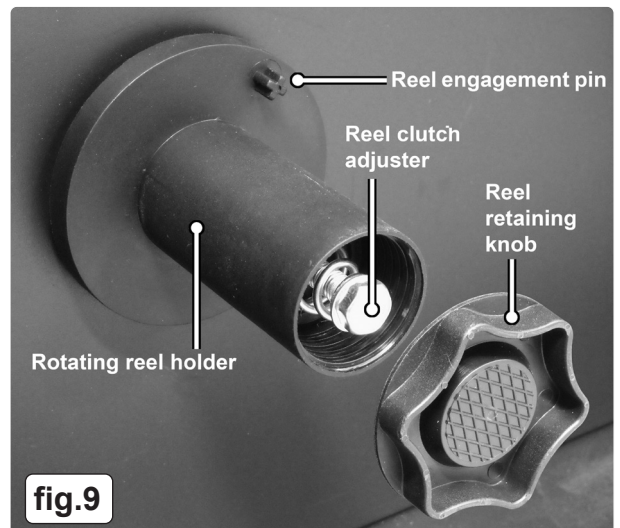
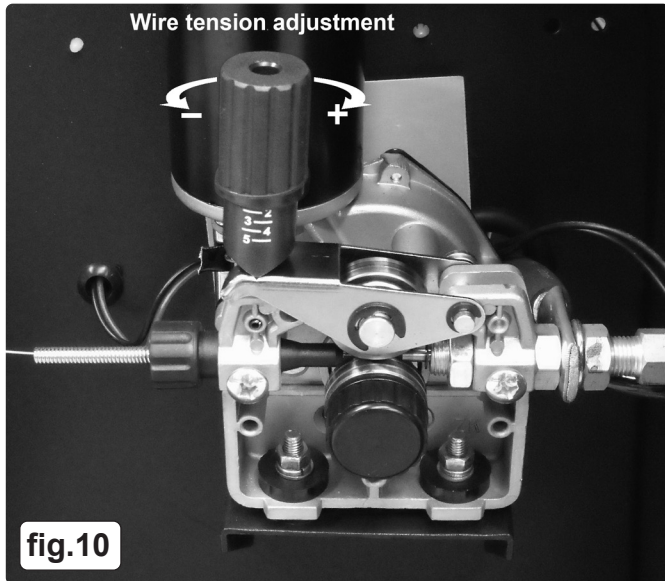

fig.9

6 . SETTING UP THE WIRE FEED

MAKE SURE THAT THE WIRE FEED ROLLER, THE WIRE GUIDE HOSE AND THE CONTACT TIP OF THE TORCH MATCH THE DIAMETER AND TYPE OF WIRE TO BE USED AND ARE FITTED CORRECTLY.



6.1 The wire feed mechanism has a lower grooved drive roller and an upper pressure roller. The pressure roller is in a separate hinged housing which is held in place and acted upon by a pressure adjustment knob as shown in fig.10 above. To access the drive mechanism pull the pressure adjustment knob over to the left and allow it to hinge downwards. As you do so the pressure roller housing will spring open to the right as shown in fig.11 below.

6.1.1 The wire drive unit is supplied with one roller which has drive grooves for $\varnothing 0.8\text{mm}$ and $\varnothing 1.0\text{mm}$ wire. Note that it is essential to place the roller the right way round on the drive mechanism.

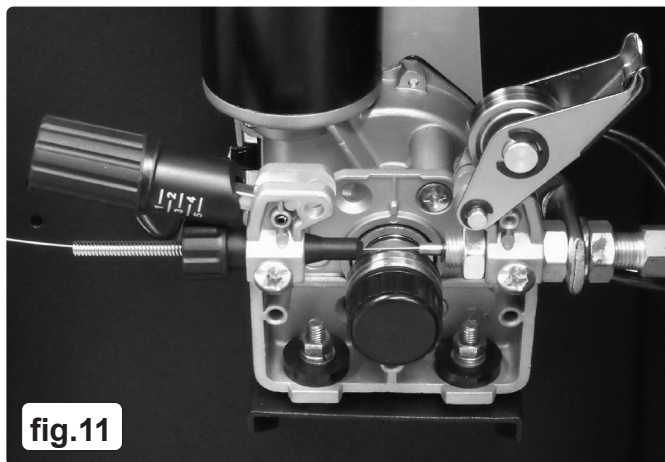

6.1.2 The roller groove size is stamped on the face of each roller adjacent to the appropriate groove. Ensure that the groove size you require is positioned furthest away from you so that it will be in line with the wire feed path.

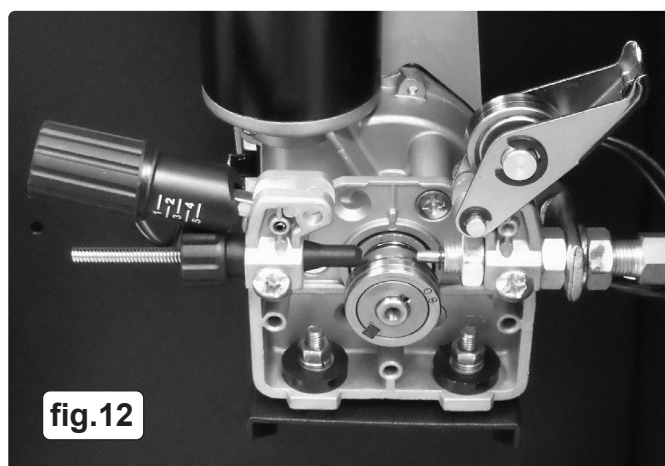

6.1.3 When changing from $\varnothing 0.8\text{mm}$ to $\varnothing 1.0\text{mm}$ wire it will be necessary to reverse the position of the roller on its carrier. Firstly unscrew and remove the black knurled knob that holds the roller and its carrier in position (see fig.12).

6.1.4 Now slide the roller and its carrier off the main drive shaft as shown below in fig.13, taking care to keep the parts together as an assembly. Note that there is a keyway in the roller which must align with the keyway on the roller carrier and the two components are held together with a close fitting square key (see fig.14).

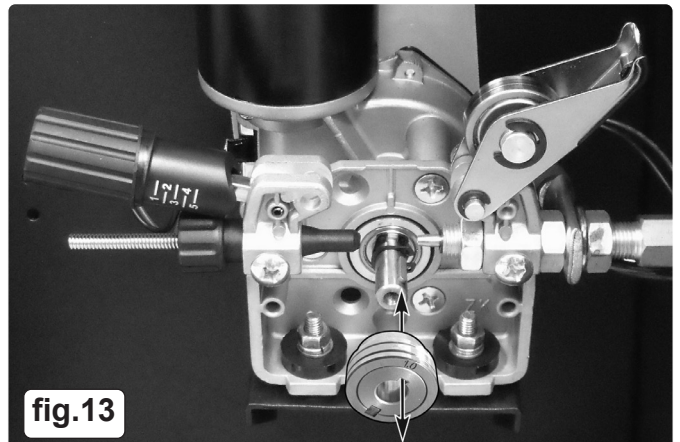

6.1.5 Once the carrier is free from the main drive, you can now slide the roller off the carrier as shown below in fig.14A. Take care not to unseat the loose key that aligns the roller with the carrier. The roller can now be reversed or replaced as required. In either instance the required drive groove must be furthest away from you at the back of the roller in order to align with the wire drive path.

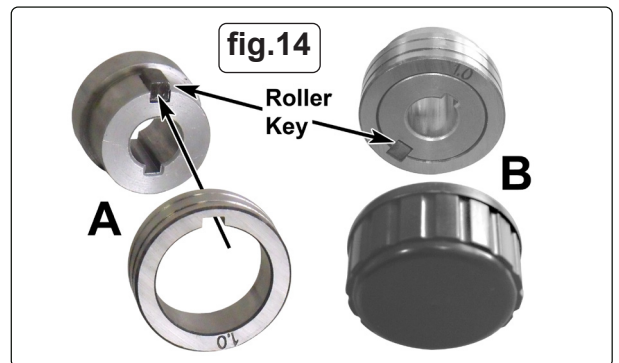

6.1.6 With the carrier, roller and key reassembled as shown in fig.14B, orientate the carrier so that the keyway in the carrier itself is aligned with the key on the wire feed drive shaft as shown in fig.13. Slide the carrier fully onto the drive shaft and fix it in position by screwing into place the black knurled knob previously removed.

6.2 Straighten about 50-100mm of spool wire (*do not allow wire to uncoil*). Ensure that the wire is undistorted and clean cut with no burrs or sharp points. (Note: Burrs or sharp points at wire tip may damage the torch liner.) Gently push the wire through the flexible wire guide until it emerges into the wire feed drive unit. Guide the wire over the roller and into the torch fitting wire guide by 50 to 100mm.

6.2.1 Close and hold down the pressure roller housing then hinge the pressure knob upwards and onto the housing until it snaps into position. Set an intermediate pressure between marks 2 and 3. Turning the knob clockwise increases the pressure. Turning the knob anti-clockwise decreases the pressure. (See fig.10).

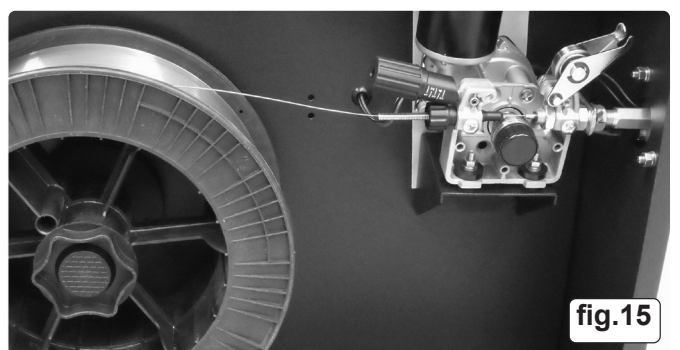

6.3 FEEDING WIRE THROUGH TO THE TORCH.

6.3.1 Before feeding the wire through to the torch, the gas cup and contact tip should be removed as shown in fig.16.

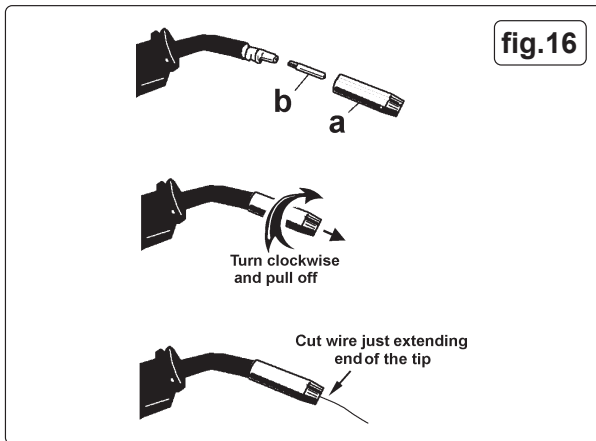

- 6.3.2 The gas cup is a friction fit onto the torch and can be pulled off with a twisting action in either direction. Unscrew the copper contact tip using the maintenance spanner provided across the 6mm flats of the contact tip. It has a conventional right hand thread.
 - 6.3.3 To feed the wire through to the torch it will be necessary to power up the welder.
 - 6.3.4 The wire is required to feed through the full length of the torch cable and if possible it should be laid out straight. If this is not possible the cable should not be coiled at a diameter of less than 1mtr.
 - 6.3.5 Check that the welder POWER switch is in the 'OFF' position, and that the earth clamp is isolated and away from the torch tip.
 - 6.3.6 Connect the welder to the mains power supply and set the voltage switch to "1".
 - 6.3.7 Using the wire feed speed control (welding current), set the knob to position 5 or 6, (the higher the number the faster the speed). See figs.17 & 18. Keep the torch cable as straight as possible and press the torch switch to feed the wire through to the torch.
 - 6.3.8 When the wire has fed through, switch welder off, unplug from mains.
 - 6.3.9 Replace contact tip and gas cup. Cut wire so that it is protruding 1/4" from the cup.
- ❑ **WARNING!** During these operations the wire is live and subject to mechanical stress; therefore, if adequate precautions are not taken the wire could cause hazardous electric shock, injury and striking of electric arcs. Do not direct the torch tip towards parts of the body and keep the torch away from the gas bottle.

6.4 SETTING WIRE TENSION.

IMPORTANT: You must set the correct tension, too little or too much tension will cause problematic wire feed and result in poor welding.

- 6.4.1 Tension between rollers is checked by slowing down the wire between your fingers. If the top feed rollers skid the tension is correct. Use as low a tension as possible, too high a tension will deform wire and result in a blown fuse on the printed circuit board. Adjust tension by turning the pressure knob as shown in fig.10.

6.5 CLUTCH ADJUSTMENT

It is essential that the clutch is adjusted correctly. Once the wire is fed through the torch, switch on the machine and set the wire speed and voltage switch to maximum. Depress the torch switch and release quickly. If spool overruns it indicates that the clutch is too loose. Tighten the reel clutch adjuster (located in the centre of the reel holder (fig.9), and test the machine as above until the wire stops over running.

❑ **WARNING!** DO NOT over tighten the clutch as this will cause wire feed problems.

6.6 WIRE FEED CONTROL

- 6.6.1 The wire feed speed can be set using the 'Welding Current' control situated on the front panel of each welder. (See figs.17 & 18). Use this rotary control to set the basic wire feed speed required by the welding parameters of the weld to be executed.

7. POWERMIG CONTROLS

7.1 CONTROLS - POWERMIG 3525 & 3530

- 7.1.1 Fig.17 illustrates the main panel controls for **Powermig3525**. Note that this model has a single voltage adjustment switch and one socket on the lower half of the front panel for the connection of the welding current return cable (Earthing Clamp).

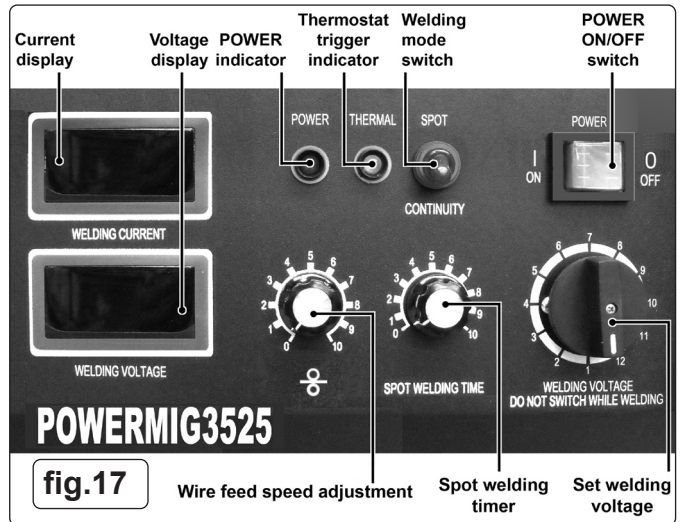

- 7.2 Fig.18 illustrates the main panel controls for **Powermig3530**. Note that this model has two voltage adjustment switches, one for coarse adjustment and one for fine adjustment. There is a socket on the lower half of the front panel for the connection of the welding current return cable (Earthing Clamp).



- 7.3 **SYSTEM PROTECTION**
To provide a level of protection against faults such as short circuits or overheating, various safety features are incorporated into the welder unit. The power input is protected by a 3 Amp fuse located in the upper part of the wire feed compartment. The supply circuit is protected by an 8 Amp fuse located on the left hand side of the rear panel. A thermostat is built into the system to protect against overheating. The indicator light comes on when overheating occurs and cuts off the power supply; it will reset automatically within a few minutes, after cooling down.

8. WELDING PRINCIPLES

IMPORTANT.

Should you have no welding experience, we recommend you seek training from an expert source to ensure your personal health & safety. You must familiarise yourself with welding applications and limitations, and specific potential hazards peculiar to welding. Good Mig welding may be achieved only with continued, supervised practice.

- 8.1 **Mig/Mag welding.** (See fig.19). A reel of welding wire is placed on the reel holder and automatically fed through an insulated liner in the torch to its tip. The torch consist of a switch, liner, gas hose, and control cable. The switch activates the wire feed roller and the gas flow. Releasing the switch stops wire feed and gas flow. The weld current is transferred to the electrode (the wire) from the contact tip at the torch end.

Wire speed must be adjusted according to power output. The higher the current the faster the wire speed. A gas cup fits over the contact tip to direct gas flow towards the weld ensuring the arc welding process is shielded from oxidising air contamination (fig.19). The shielding gas also assists heating of the weld. The torch is connected to the positive side of a DC rectifier, and negative clamp is attached to the workpiece.

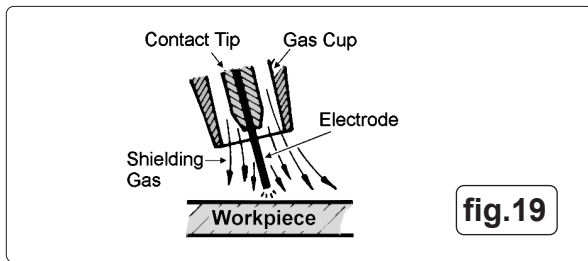

8.2 Preparation for welding.

IMPORTANT: BEFORE YOU COMMENCE, MAKE SURE THE MACHINE IS SWITCHED OFF AT THE MAINS. IF WELDING A VEHICLE, DISCONNECT THE BATTERY OR FIT AN ELECTRONIC CIRCUIT PROTECTOR. ENSURE YOU READ AND UNDERSTAND THE SAFETY INSTRUCTIONS IN CHAPTER 1.

8.2.1 Connecting the Earth Lead.

Connect the earth lead as described in section 5.5. To ensure a complete circuit, the earth lead clamp must be securely attached to the workpiece that is to be welded.

- a) Best connection is obtained by grinding the point of contact on the workpiece before connecting clamp to the workpiece.
- b) The weld area must also be free of paint, rust, grease, etc.
- c) If welding a vehicle, disconnect vehicle battery or fit an "Electronic Circuit Protector" to battery, (available from your Sealey dealer).

8.2.2 The wire feed rate rotary controls are used to set the speed of the wire feed. In principle, the lower the amperage number the slower the wire speed.

8.3 Gas types and their use.

Welding mild steel with CO₂ gas is appropriate for most welding tasks where spatter and high build up of weld do not pose a problem. To achieve a spatter free and flat weld however, as a guideline, use an Argon/CO₂ mixture. *To weld aluminium use:* ✓ Argon gas or Argo-Helium mixture, ✓ 0.8mm Contact Tip, ✓ 0.8mm Aluminium Wire, (MIG/2/KAL08) ✓ Liner (red) Aluminium.

9.2 ALUMINIUM WELDING

Argon or an Argon-Helium mixture should be used for shielding. The wire used must have the same characteristics as the material to be welded. Always use an alloy wire (i.e. aluminium/silicium); **DO NOT** use pure aluminium wire. A problem you may experience when aluminium MIG welding is in pulling the wire for the whole length of the torch, as aluminium has poor mechanical characteristics. The smaller the diameter of wire the more difficult the wire feed may be. To overcome this problem do the following.

- Use contact tip suitable for aluminium.
- Replace the wire puller rollers with aluminium compatible rollers.
- Replace the steel guide hose for wire feed with a Teflon guide hose.
- For more information contact your local Sealey dealer.

9.3 SPOT WELDING (fig.20)

9.3.1 Ensure that the welding mode switch is set to the 'SPOT' welding position.

9.3.2 This model has the capability to spot weld two overlapping metal sheets and is equipped with an adjustable timer which allows ideal spot welding time to be set and therefore the creation of spot-welds which have the same characteristics. In order to use the machine for spot welding, it should be set-up as follows:

9.3.3 Replace the nozzle of the torch with the nozzle required for spot welding. The castellations on the cup keep it the correct distance from the weld pool and allow the shielding gas to escape. The nozzle is also used to push the two pieces being welded together.

9.3.4 Set the rotary current adjustment switch / switches to the highest setting.

Set the wire feed speed at almost maximum speed. Turn ON the Timer control and set the spot welding time according to the thickness of the metal sheets.

9.3.5 To carry out the spot welding; rest the nozzle of the torch on the surface of the first metal sheet, then press the torch button to start welding: the wire will melt the first sheet, pass through this sheet and into the second, making a molten wedge between the two metal sheets.

9.3.6 The torch button should be pressed until the timer interrupts the welding. This system allows spot-welding to be carried out which would not normally be possible with conventional spot welders, since metal sheets can be joined which do not allow access to the rear side of the workpiece.

This system also makes the operator's work much easier thanks to the extremely light-weight torch in comparison to conventional spot welding equipment.

The application limits of this system depend on the thickness of the first metal sheet; the second sheet may be thicker.

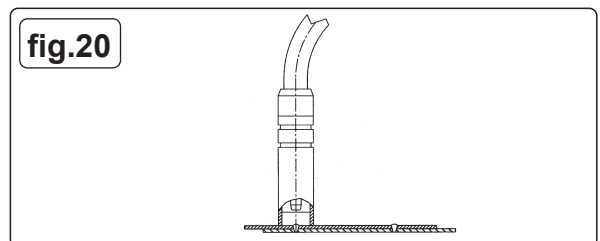

9. COMMENCING WELDING

9.1 COMMENCING WELDING.

9.1.1 Ensure that the welding mode switch is set to the 'CONTINUITY' welding position.

9.1.2 Before carrying out difficult sections of welding, tests should be carried out on scrap pieces of metal. These tests should be carried out to find the best control settings in order to obtain the best welding result. As a starting point refer to the welding guide below. If the arc melts in drops and tends to go out, the speed of the wire should be increased or the welding current decreased. If, however, the wire hits the piece violently and causes material to be projected, the wire speed should be reduced.

9.1.3 It should be remembered that in order to obtain the best results, each type of wire is suited to a specific current and wire feed speed. Therefore, for difficult sections of welding and welding which requires a great deal of time, wires with different diameters should be tried so that the most suitable may be chosen.

9.1.4 Turn on and adjust the protective gas using the pressure regulator. Adjust to a flow rate of 5-7 l/min.

9.1.5 NOTE: At the end of the job, remember to turn off the protective gas.

9.1.6 Switch the welder on and set the welding current by means of the rotary switches and by referring to the welding reference table below.

9.1.7 Ensure that the earth clamp is in contact with the workpiece.

9.1.8 Press the torch button, keeping the torch at a safe distance from the workpiece.

WELDING REFERENCE TABLE (for general guidance only)

Material Thickness (mm)	Wire Diameter (mm)	Liner Inner Diameter (mm)	Liner Specification (mm)	Current (Amps)	Voltage (Volts)	Gas Flow (l/min)
0.8 to 1.5	Ø0.8	Ø1.4	1.2 x 1.6 (blue)	50 to 90	17 to 18	6
1.0 to 2.5	Ø0.8	Ø1.4	1.2 x 1.6 (blue)	60 to 100	18 to 19	7
2.5 to 4.0	Ø0.8	Ø1.4	1.2 x 1.6 (blue)	100 to 140	21 to 24	8
2.0 to 5.0	Ø1.0	Ø1.6	1.2 x 1.8 (black)	70 to 120	19 to 21	9
5.0 to 10	Ø1.0	Ø1.6	1.2 x 1.8 (black)	120 to 170	23 to 26	10

10. MAINTENANCE

WARNING! Ensure the unit is disconnected from the mains power supply before performing any maintenance or service.

- 10.1** Regularly check all welding cables and secondary terminals to ensure they are in good order and connected correctly, also check during welding to ensure they are not overheating.
- 10.2** Check that the gas hose connections are tight and that there are no gas leaks.
- 10.3** **Wire feed unit.**
Check the wire feed unit at regular intervals. The feed roller wire guide plays an important part in obtaining consistent results. Poor wire feeding affects welding. Clean the rollers weekly, especially the feed roller groove, removing all dust deposits from the feeder area.
- 10.4** **Changing Feed Roller / Rollers *IMPORTANT:*** Set up the feed rollers according to the wire size required for the job in hand. Refer to section 6.
- 10.5** **Torch**
Protect torch cable assembly from mechanical wear. Also do not allow the torch or its cable to come into contact with hot surfaces, especially a hot workpiece as this would cause the insulating materials to melt, making the torch unsafe and unusable.
- Make regular checks on the gas pipe and connector seals;
- Every time the wire reel is changed, blow out the wire-guide hose using dry compressed air (max. 5 bar) to make sure it is not damaged;
- Before using the welding machine, always check the torch terminal parts for wear and make sure they are assembled correctly: nozzle, contact pipe, gas diffuser.
- 10.6** **Contact Tip (to remove the tip refer to section 6.3 and fig.16).**
The contact tip is a consumable item and must be replaced when the hole becomes enlarged or oval. The contact tip **MUST** be kept free from spatter to ensure an unimpeded flow of gas.
- 10.7** **Gas Cup (to remove the tip refer to section 6.3 and fig.16).**
The gas cup must also be kept clean and free from spatter. Build up

of spatter inside the gas cup can cause a short circuit at the contact tip which will result in either the fuse blowing on the printed circuit card, or expensive machine repairs. To keep the contact tip free from spatter, we recommend the use of Sealey anti-spatter spray (MIG/722307) available from your Sealey Dealer.

10.8 Changing Fuses

The fuses are located on the back panel of the main welding unit and are mainly blown for the following reasons:

- ✓ Spatter collecting in the gas cup, causing contact tip to short circuit.
- ✓ Wire tension is too great. ✓ A sudden surge of current.

10.9 INTERNAL MAINTENANCE / INSPECTION

INTERNAL INSPECTION AND MAINTENANCE OPERATIONS SHOULD BE CARRIED OUT ONLY AND EXCLUSIVELY BY SKILLED OR AUTHORISED ELECTRICAL/MECHANICAL TECHNICIANS.

WARNING BEFORE REMOVING THE WELDING MACHINE PANELS AND WORKING INSIDE THE MACHINE MAKE SURE THE WELDING MACHINE IS SWITCHED OFF AND DISCONNECTED FROM THE MAIN POWER SUPPLY OUTLET.

If checks are made inside the welding machine while it is live, this may cause serious electric shock due to direct contact with live parts and/or injury due to direct contact with moving parts.

- Inspect the welding machine regularly, with a frequency depending on use and the dustiness of the environment, and remove the dust deposited on the transformer, reactance and rectifier using a jet of dry compressed air (max. 10 bar).
- Do not direct the jet of compressed air on the electronic boards; these can be cleaned with a very soft brush or suitable solvents.
- At the same time make sure the electrical connections are tight and check the wiring for damage to the insulation.
- At the end of these operations re-assemble the panels of the welding machine and screw the fastening screws right down.
- Never, ever carry out welding operations while the welding machine is open.

11. TROUBLESHOOTING

PROBLEM	POSSIBLE CAUSE	REMEDY (Numbers refer to chapter and item heading)
1. Power source stops	Overheating protection activated due to overload	Protection automatically resets when transformer has cooled (about 15 min).
2. No weld current	Rectifier blown	Replace rectifier.
3. No weld current	Bad connection between clamp & workpiece Break in earth lead Break in torch lead	Clean or grind contact surface and weld area. Repair or replace earth lead. Repair or replace torch, lead.
4. Feed motor not working, lamp is on	Fuse blown Gear damaged or worn Motor defective	Replace fuse 1.5 amp. Contact service agent. Replace motor (Contact service agent).
5. Wire does not feed, feed roller rotates	Pressure roller improperly adjusted Dirt, copper, dust, etc, have collected in torch liner Gas cup (Nozzle) or tip defective. Faulty speed control Deformed wire	Adjust tension. Clean the liner from the machine forward. Use compressed air. If too much dirt, replace the liner. Replace gas cup (nozzle) and/or tip. (See section 6.3). Check roller tension and adjust it if necessary (See section 6.4)
6. Wire feeds unevenly.	Dirt, etc, in liner Gas cup (Nozzle) or Tip defective Gas cup (Nozzle) spattered Feed roller groove clogged Feed roller groove deformed Pressure roller tension improper	Clean the liner from the machine forward. Use compressed air. Replace gas cup (nozzle) and/or tip. (See fig.16). Clean or replace gas cup (nozzle) (See fig.16). Clean feed roller. (See section 10.3). Replace feed roller. (See section 6.1.5). Adjust tension. (See section 6.4).
7. Unstable arc.	Incorrect settings Impurities in weld area Worn or defective gas cup (nozzle)	Check settings. (Refer to Welding Reference Table). Clean and/or grind workpiece. (See section 8.2.1). Replace gas cup (nozzle). (See fig.16).
8. Porous weld	No gas Gas cup clogged Draft blowing away shielding gas Rusty or dirty joints Torch too far from or at wrong angle to work Gas leak Dirty Workpiece	Open gas cylinder, regulate gas flow. Clean or replace cup. (See fig.16). Screen off welding site or increase gas flow. Clean or grind the workpiece (See section 8.2.1). The distance from gas cup to workpiece should be 8-10mm Check contact tip and nozzle. Check hoses, connections and torch assembly. (See section 5.5). Press the gas cup into correct position.
9. Electrode sticking in gas cup (nozzle)	Worn or defective gas cup (nozzle) Electrode deformed Wire speed too slow	Replace gas cup (nozzle). (See fig.16). Check roller tension. (See section 6.4). Adjust wire feed rate control. (See section 6.6).
10. Irregular weld bead	Torch incorrectly held Wire weaving in weld pool	Use correct torch angle. Check roller tension and adjust as needed. (See section 6.4).
11. Weld bead too narrow and raised	Weld current too high Weld speed too low	Increase power and wire speed. Move torch slower and weave a little more.
12. Weld bead too wide	Weld current too high Weld speed too low Arc too long	Decrease power and wire speed. Move torch faster and weave less. Bring torch closer to workpiece.
13. Poor penetration	Weld current too high Arc too long	Increase power and wire speed. Bring torch closer to workpiece.
14. Excessive penetration	Weld current too high weld speed too slow incorrect distance of torch to workpiece	Decrease power and wire speed. Move torch faster. Torch distance should be 8-10mm.

15. Fuse blowing	Tension too great Gas cup contact tip clogged	Release tension. (See section 6.2.1). Clean gas cup and contact tip. (See fig.16).
16. Coils of wire on reel overlap, or wire is oxidised. Coils break or fall under wheel.	Tension too loose or tight. Coil damaged or wire twisted.	Reset tension. Change wire reel.
17. Wire runs through torch but there is no welding current.	Defective contactor. Worn contacts of contactor regulator. Regulation switch problem Faulty rectifier. Fault on electronic circuit of contactor. Work cable not connected correctly.	Check coil ends, change coil if necessary. Check, clean contacts, change if oxidation is present. Check secondary voltage for each switch setting. Disconnect rectifier from secondary, check each diode goes one way only. If not change rectifier. Change control module. Connect work clamp directly to workpiece. Check wire is in good condition and making good contact with clamp.



ENVIRONMENT PROTECTION

Recycle unwanted materials instead of disposing of them as waste. All tools, accessories and packaging should be sorted, taken to a recycling centre and disposed of in a manner which is compatible with the environment. When the product becomes completely unserviceable and requires disposal, drain any fluids (if applicable) into approved containers and dispose of the product and fluids according to local regulations.



WEEE REGULATIONS

Dispose of this product at the end of its working life in compliance with the EU Directive on Waste Electrical and Electronic Equipment (WEEE). When the product is no longer required, it must be disposed of in an environmentally protective way. Contact your local solid waste authority for recycling information.

Note: It is our policy to continually improve products and as such we reserve the right to alter data, specifications and component parts without prior notice.

Important: No Liability is accepted for incorrect use of this product.

Warranty: Guarantee is 12 months plus an additional 24 months on the main transformer, from purchase date, proof of which is required for any claim.

Sealey Group, Kempson Way, Suffolk Business Park, Bury St Edmunds, Suffolk. IP32 7AR



01284 757500



01284 703534



sales@sealey.co.uk



www.sealey.co.uk